

Europe Series

Including the versions 80 A, 160 A, 320 A, this range is in accordance with the current Norms DIN VDE 0623-589, defining unified distances between centres and representing the evolution of the previous DIN Norms.

The series includes 2 versions:

- ▲ Shock resistant housing – suitable for all applications requiring high resistance against shocks
- ▲ Acid- proof polymer housing – suitable for applications needing elevated resistance against acid

The improved version 320A is also available for the cabling of a 95mm diameter cable, feature that allows to further enlarge the range of use of the products on different applications.

[RAVIOLI Euro-DIN 80](#)

[RAVIOLI Euro-DIN 160](#)

[RAVIOLI Euro-DIN 320](#)



DIN 80



Female connector

Item	Ordering code	Description
5/6/7/8/9/10	EPBC80AR1 EPBC80ST1	RAVIOLI DIN 80 Female – 16/25 mm ² – Acid Proof – Grey Coding Pin RAVIOLI DIN 80 Female – 16/25 mm ² – Shock Resistant – Grey Coding Pin
2	EXP80PRAR EXP80PRST	Pilot Contact Ravioli DIN 80 Female – 2 pieces Pilot Contact Ravioli DIN 80 Female – 2 pieces – not acid resistant
3	EXP80SEC	Auxiliary Contact Ravioli 80 Female – 2 pieces
4	EAIRTUBE80P	Air Adapter RAVIOLI DIN 80 Female
7	E34404 E34434 E34435	Coding Pin RAVIOLI DIN 80 – Grey Coding Pin RAVIOLI DIN 80 – Green Coding Pin RAVIOLI DIN 80 – Yellow

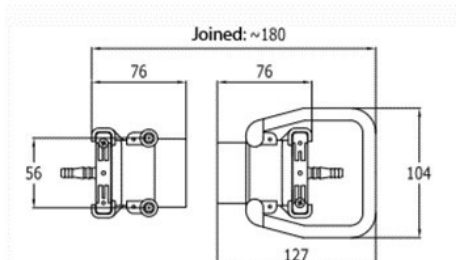
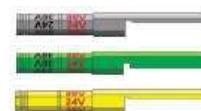



Male connector

Item	Ordering code	Description
5/6/7/8/9/10	ESBC80AR1 ESBC80ST1	RAVIOLI DIN 80 Male – 16/25 mm ² – Acid Proof – Grey Coding Pin RAVIOLI DIN 80 Male – 16/25 mm ² – Shock Resistant – Grey Coding Pin
2	EXS80PRAR EXS80PRST	Pilot Contact Ravioli DIN 80 Male – 2 pieces Pilot Contact Ravioli DIN 80 Male – 2 pieces – not acid resistant
3	EXS80SEC	Auxiliary Contact Ravioli 80 Male – 2 pieces
4	EAIRTUBE80S	Air Adapter RAVIOLI DIN 80 Male
7	E34404 E34434 E34435	Coding Pin RAVIOLI DIN 80 – Grey Coding Pin RAVIOLI DIN 80 – Green Coding Pin RAVIOLI DIN 80 – Yellow

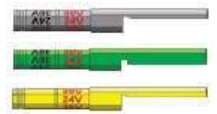

Accessories

Picture	Ordering code	Description
	EMAN80AR	Handle RAVIOLI DIN 80 – Acid Proof
	EMAN80ARRED	Handle RAVIOLI DIN 80 – Acid Proof – Red
	EMAN80ST	Handle RAVIOLI DIN 80 – Not Acid Proof



Ordering code

Example:

XXXX 80 XX X

Gender: _____

ESBC = Plug

EPBC = Socket

EKPM = Socket + handle

Range: _____

80

Version: _____

AR = Acid-Proof

ST = Shock Resistant

Color Coding Pin: _____

1 = Grey

2 = Yellow

3 = Green

DIN 160



Female connector

Item	Ordering code	Description
5/6/7/8/9/10	EPBC160AR1 EPBC160AR1-25 EPBC160ST1 EPBC160ST1-25	RAVIOLI DIN 160 Female – 35/50 mm ² – Acid Proof – Grey Coding Pin RAVIOLI DIN 160 Female – 25/50 mm ² – Acid Proof – Grey Coding Pin RAVIOLI DIN 160 Female – 35/50 mm ² – Shock Resistant – Grey Coding Pin RAVIOLI DIN 160 Female – 25/50 mm ² – Shock Resistant – Grey Coding Pin
2	EXP160320PRAR EXP160320PRST	Pilot Contact Ravioli DIN 160/320 Female – 2 pieces Pilot Contact Ravioli DIN 160/320 Female – 2 pieces – not acid resistant
3	EXP160SEC	Auxiliary Contact Ravioli 160 Female – 2 pieces
4	EAIRTUBE160P	Air Adapter RAVIOLI DIN 160 Female
7	E29304 E29366 E29367	Coding Pin RAVIOLI DIN 160/320 – Grey Coding Pin RAVIOLI DIN 160/320 – Green Coding Pin RAVIOLI DIN 160/320 – Yellow

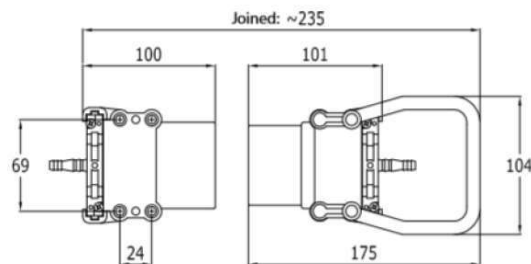
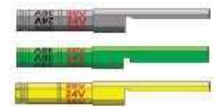

Height with mounted standard handle: 57 mm.
Height with mounted flat handle: 40,5 mm.

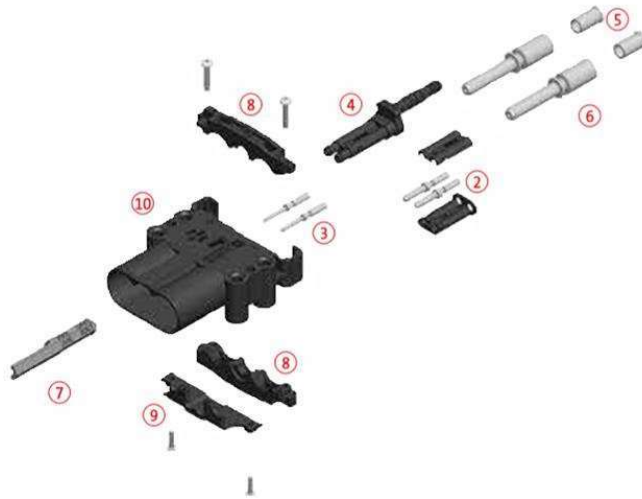

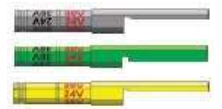

Male connector

Item	Ordering code	Description
5/6/7/8/9/10	ESBC160 ESBC160-25 ESBC160ST1 ESBC160ST1-25	RAVIOLI DIN 160 Male – 35/50 mm ² – Acid Proof – Grey Coding Pin RAVIOLI DIN 160 Male – 25/50 mm ² – Acid Proof – Grey Coding Pin RAVIOLI DIN 160 Male – 35/50 mm ² – Shock Resistant – Grey Coding Pin RAVIOLI DIN 160 Male – 25/50 mm ² – Shock Resistant – Grey Coding Pin
2	EXS160320PRAR EXS160320PRST	Pilot Contact Ravioli DIN 160/320 Male – 2 pieces Pilot Contact Ravioli DIN 160/320 Male – 2 pieces – not acid resistant
3	EXS160SEC	Auxiliary Contact Ravioli 160 Male – 2 pieces
4	EAIRTUBE160S	Air Adapter RAVIOLI DIN 160 Male
7	E29304 E29366 E29367	Coding Pin RAVIOLI DIN 160/320 – Grey Coding Pin RAVIOLI DIN 160/320 – Green Coding Pin RAVIOLI DIN 160/320 – Yellow



Accessories

Picture	Ordering code	Description
	ERID50-25	Reducing Bushing RAVIOLI 50 mm ² – 25 mm ²
	EM160320ST EM160320AR EM160320ARRED	Handle RAVIOLI DIN 160/320 – Euro Handle RAVIOLI DIN 160/320 – Acid Proof Handle RAVIOLI DIN 160/320 – Acid Proof – Red
	EM160320STP	Flat Handle RAVIOLI DIN 160/320



Ordering code

Example:

XXXX 160 XX X

Gender: _____

ESBC = Plug

EPBC = Socket

EKPM = Socket + handle

Range: _____

160

Version: _____

AR = Acid-Proof

ST = Shock Resistant

Color Coding Pin: _____

1 = Grey

2 = Yellow

3 = Green

DIN 320



Female connector

Item	Ordering code	Description
5/6/7/8/9/10	EPBC320AR1 EPBC320AR1-95 EPBC320ST1 EPBC320ST1-95	RAVIOLI DIN 320 Female – 50/70 mm ² – Acid Proof – Grey Coding Pin RAVIOLI DIN 320 Female – 95 mm ² – Acid Proof – Grey Coding Pin RAVIOLI DIN 320 Female – 50/70 mm ² – Shock Resistant – Grey Coding Pin RAVIOLI DIN 320 Female – 95 mm ² – Shock Resistant – Grey Coding Pin
2	EXP160320PRAR EXP160320PRST	Pilot Contact Ravioli DIN 160/320 Female – 2 pieces Pilot Contact Ravioli DIN 160/320 Female – 2 pieces – not acid resistant
3	EXP320SEC	Auxiliary Contact Ravioli 320 Female – 2 pieces
4	EAIRTUBE320P	Air Adapter RAVIOLI DIN 320 Female
7	E29304 E29366 E29367	Coding Pin RAVIOLI DIN 160/320 – Grey Coding Pin RAVIOLI DIN 160/320 – Green Coding Pin RAVIOLI DIN 160/320 – Yellow

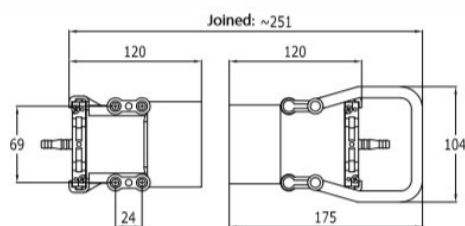

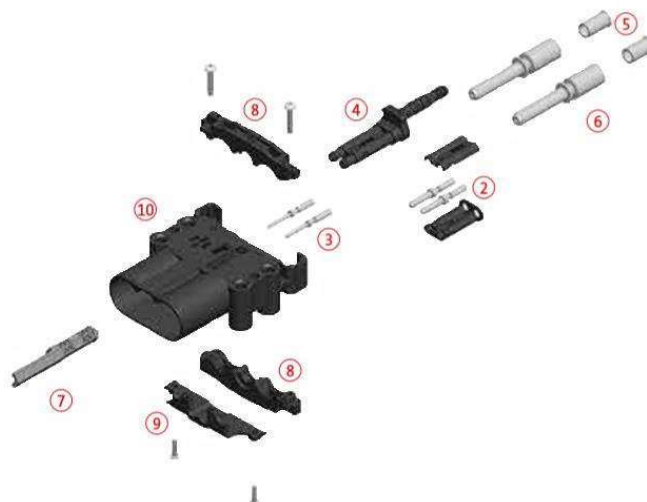

Height with mounted standard handle: 64 mm.
Height with mounted flat handle: 48 mm.

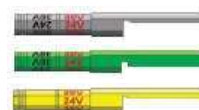

Male connector		
Item	Ordering code	Description
5/6/7/8/9/10	ESBC320AR1	RAVIOLI DIN 320 Male – 50/70 mm ² – Acid Proof – Grey Coding Pin
	ESBC320AR1-95	RAVIOLI DIN 320 Male – 95 mm ² – Acid Proof – Grey Coding Pin
	ESBC320ST1	RAVIOLI DIN 320 Male – 50/70 mm ² – Shock Resistant – Grey Coding Pin
	ESBC320ST1-95	RAVIOLI DIN 320 Male – 95 mm ² – Shock Resistant – Grey Coding Pin
2	EXS160320PRAR	Pilot Contact Ravioli DIN 160/320 Male – 2 pieces
	EXS160320PRST	Pilot Contact Ravioli DIN 160/320 Male – 2 pieces – not acid resistant
3	EXS320SEC	Auxiliary Contact Ravioli 320 Male – 2 pieces
4	EAIRTUBE320S	Air Adapter RAVIOLI DIN 320 Male
7	E29304	Coding Pin RAVIOLI DIN 160/320 – Grey
	E29366	Coding Pin RAVIOLI DIN 160/320 – Green
	E29367	Coding Pin RAVIOLI DIN 160/320 – Yellow



Accessories		
Picture	Ordering code	Description
	ERID50-25 ERID70-35	Reducing Bushing RAVIOLI 50 mm ² – 25 mm ² Reducing Bushing RAVIOLI 70 mm ² – 35 mm ²
	EM160320ST EM160320AR EM160320ARRED	Handle RAVIOLI DIN 160/320 – Euro Handle RAVIOLI DIN 160/320 – Acid Proof Handle RAVIOLI DIN 160/320 – Acid Proof – Red
	EM160320STP	Flat Handle RAVIOLI DIN 160/320



Ordering code

Example:
XXXX 320 XX X

Gender: _____

- ESBC = Plug
- EPBC = Socket
- EKPM = Socket + handle

Range: _____

320

Version: _____

- AR = Acid-Proof
- ST = Shock Resistant

Color Coding Pin: _____

- 1 = Grey
- 2 = Yellow
- 3 = Green